



szach-mat
windows with passion

PVC WINDOWS



MISSION

We believe that out of passion for what we do, we deliver the highest quality services to provide our customers with full comfort and security.

VISION

Szach-Mat as:

- quality leader
- a company with a credible image
- a friendly workplace

VALUES

Our key to success is:

- cooperation
- sincerity
- honesty
- constant development
- engagement



PVC WINDOWS

What will you gain by cooperating with us?	4 - 5
Learn about Szach-Mat windows	6 - 7
COMFORT	8 - 15
PRESTIGE	16 - 19
DESIGN	20 - 31
PVC window series - Chart	32 - 33
Fittings	34 - 35
Glass	36 - 37
Accessories	38 - 39
Colours	40 - 41
Inspirations	42 - 51



Find out more:
www.szach-mat.eu

What will you gain

by cooperating with us?



1.

QUALITY

Large number of customers, many recommendations and the variety of our reference projects are the best confirmation of the quality of our windows. We have all the necessary certificates.

2.

CONSULTING

We are happy to share our knowledge, advising clients only on the best solutions. We approach each project individually and flexibly.

3.

COMMITMENT

Windows are our passion. That is why every customer can trust us to devote our time, and to do everything to ensure the highest satisfaction with our services. We do not finish our work at the time of delivery or installation of windows. Customers can always count on our support also after the warranty period.

4.

RELIABILITY

The carefully selected products and technologies we use are the guarantee of the exceptional durability of our windows.

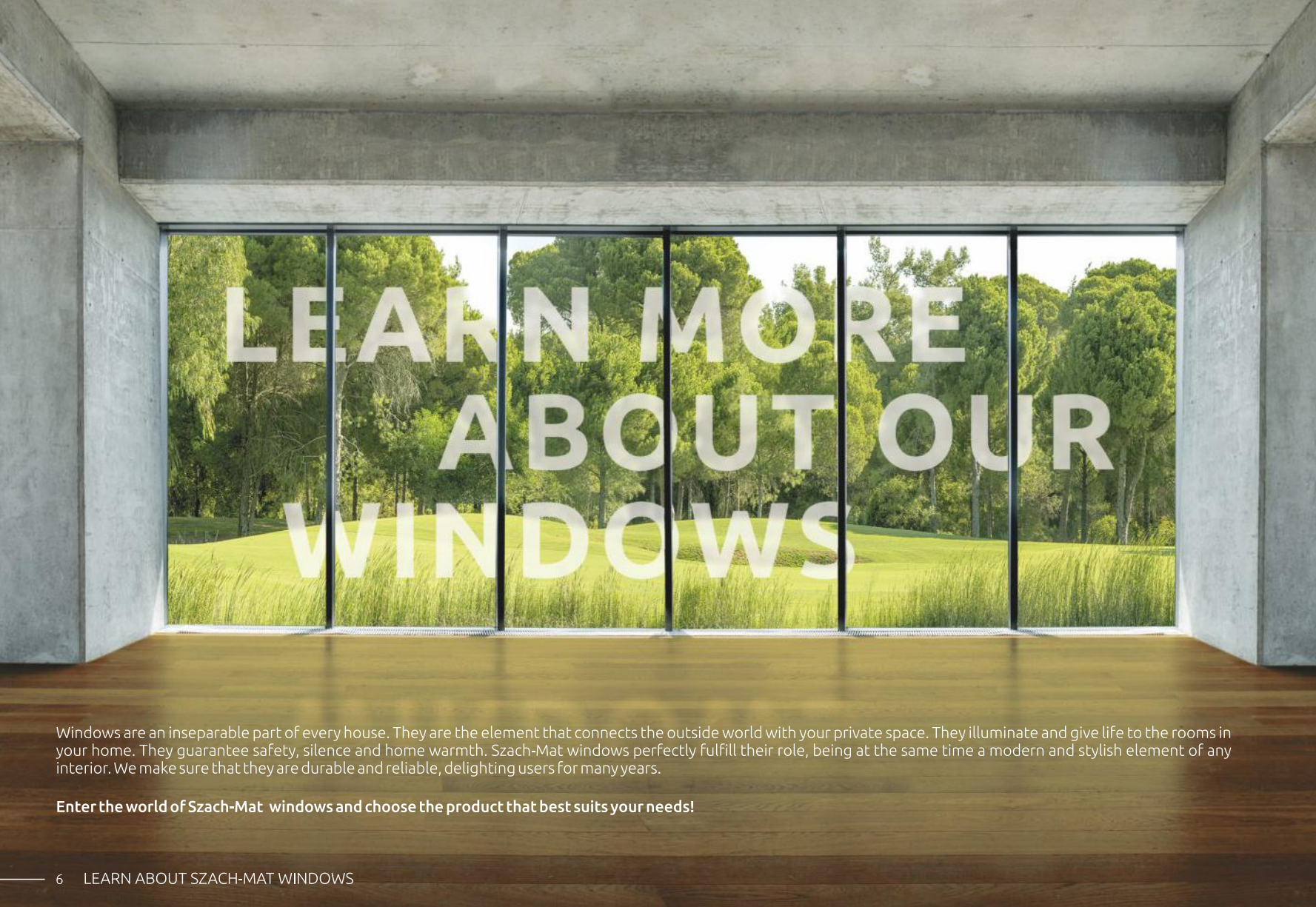

LEARN MORE ABOUT OUR WINDOWS

Windows are an inseparable part of every house. They are the element that connects the outside world with your private space. They illuminate and give life to the rooms in your home. They guarantee safety, silence and home warmth. Szach-Mat windows perfectly fulfill their role, being at the same time a modern and stylish element of any interior. We make sure that they are durable and reliable, delighting users for many years.

Enter the world of Szach-Mat windows and choose the product that best suits your needs!



DURABILITY

Thanks to the excellent quality of the materials and production, Szach-Mat windows will work for many years and guarantee failure-free operation in various conditions.



SECURITY

High resistance to burglary, even with the standard version of fittings, makes our windows provide you and your loved ones peace and security.



THERMAL INSULATION

Perfect thermal insulation parameters (U_w from 0,71 W/m²K) will keep the heat inside in the colder seasons and protect against overheating in the summer. Our windows meet the requirements of passive buildings.



SOUND-PROOF

Szach-Mat windows perfectly protect against noise. The use of an appropriate combination of profiles and glazing units will ensure acoustic comfort even in extremely noisy environments.



DESIGN

Our products are characterized by modern and elegant style. The innovative technology of V-Super welds makes the profile joints almost invisible. The variety of available finish types allows to find a perfect match for every façade and interior of the building.



MORE LIGHT

Following the latest trends, we offer solutions based on narrow frame and sash profiles and the maximally enlarged glazing area. As a result, the windows let in up to 20% more light into the room!





ALLOW YOURSELF TO
COMFORT

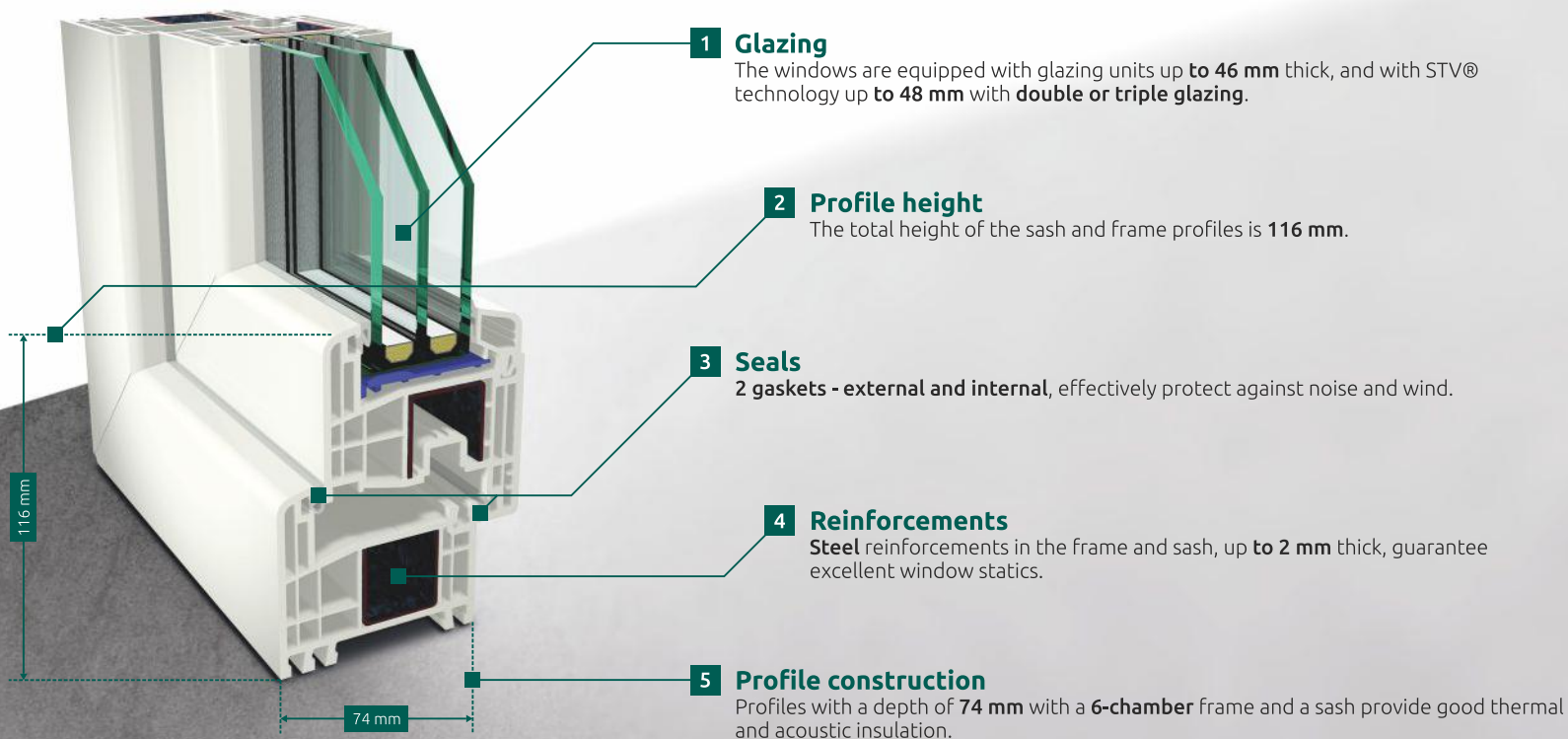

1 Glazing

The windows are equipped with glazing units up to **46 mm** thick, and with STV® technology up to **48 mm** with **double or triple glazing**.

2 Profile height

The total height of the sash and frame profiles is **116 mm**.

3 Seals

2 gaskets - external and internal, effectively protect against noise and wind.

4 Reinforcements

Steel reinforcements in the frame and sash, up to **2 mm** thick, guarantee excellent window statics.

5 Profile construction

Profiles with a depth of **74 mm** with a **6-chamber** frame and a sash provide good thermal and acoustic insulation.

When you want to combine good parameters with economy.

GEALAN S 8000

The **Gealan S 8000** profile system meets the market needs. Good parameters and favorable price make this system a popular choice for various types of buildings.



Profiles for every budget

Gealan S 8000 is the best proposition for people who value quality and low price.



Modern technologies

Profiles are adapted to dry gluing of glass with the STV® technology (page 29), which makes the window statics better and the thermal insulation coefficient lower. Moreover, the window elements are lighter, which makes it easier to close and open the windows.



Good thermal and acoustic parameters

Windows in the Gealan S 8000 system will meet the requirements of projects where a minimum value of $U_{w,0,9} = 0,9 \text{ W/m}^2$ and $R_{w,0}$ level up to 47 dB is required.



Windows ready for anything

The use of GealanACRYLCOLOR® (page 28) will make your windows not only take on new colours, but also will be scratch-resistant and will keep their shape and colour for many years. A full range of veneers is available for this system.



Easy care

Due to the large and smooth surface of the rebate, Gealan S 8000 windows are easy to maintain.

Fixed



Fixed with sash



Tilting



Side hung



Tilt and turn



Available colours
GEALAN ACRYLCOLOR®
(page 28)



B

Class

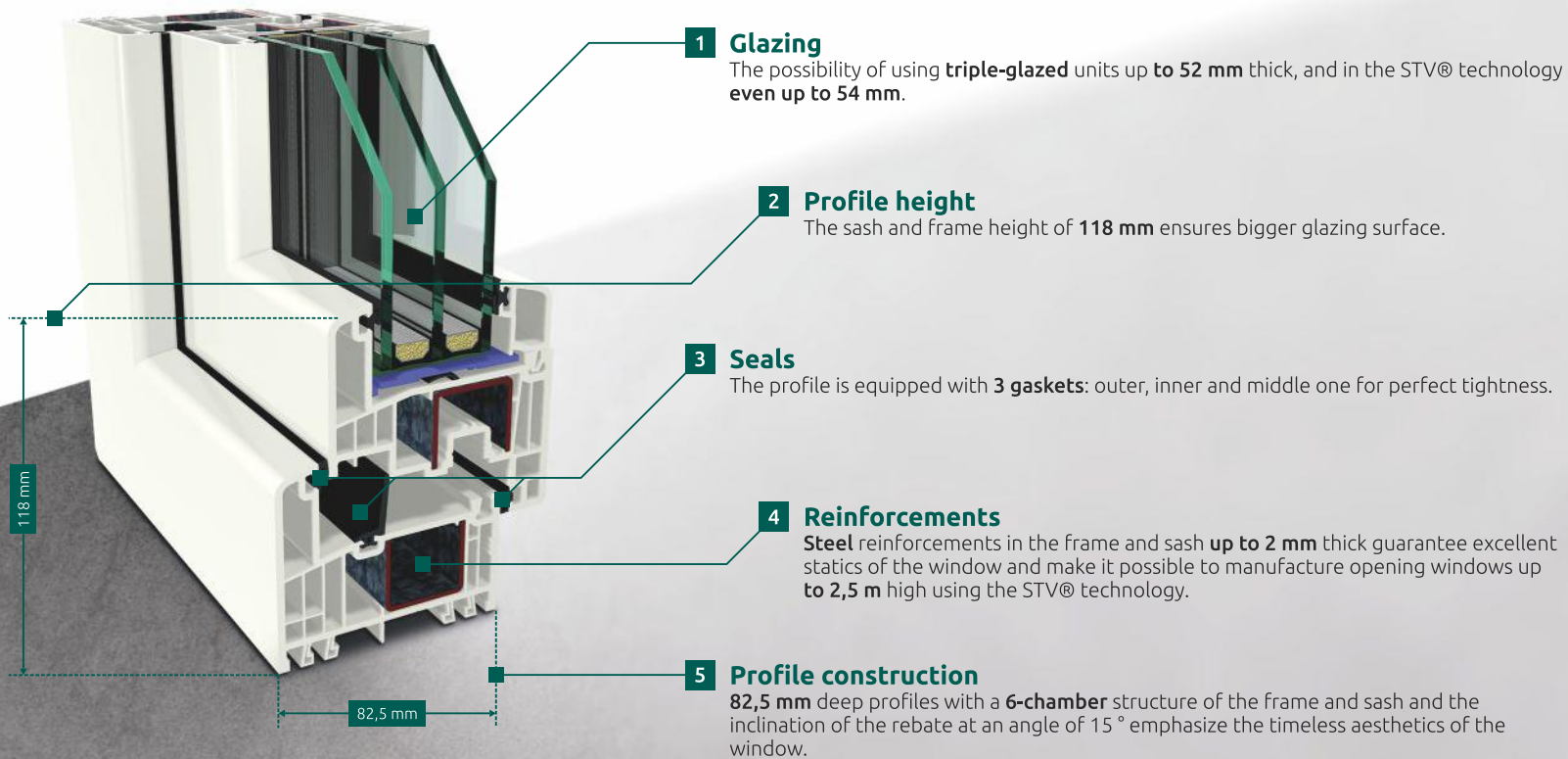

1 Glazing

The possibility of using **triple-glazed** units up to **52 mm** thick, and in the STV® technology even up to **54 mm**.

2 Profile height

The sash and frame height of **118 mm** ensures bigger glazing surface.

3 Seals

The profile is equipped with **3 gaskets**: outer, inner and middle one for perfect tightness.

4 Reinforcements

Steel reinforcements in the frame and sash **up to 2 mm** thick guarantee excellent statics of the window and make it possible to manufacture opening windows up to **2,5 m** high using the STV® technology.

5 Profile construction

82,5 mm deep profiles with a **6-chamber** structure of the frame and sash and the inclination of the rebate at an angle of **15 °** emphasize the timeless aesthetics of the window.

When it is the perfect parameters and modern design that count.

GEALAN S 9000

Gealan S 9000 profile system is a versatile, modern system dedicated to windows and doors, offering an innovative design, 3 sealing levels, excellent thermal insulation parameters and the possibility of using modern technologies.



Design

Low profiles and a design inclination of the rebates at an angle of 15° will give your rooms a modern look.



Modern technologies

Profiles are adapted to dry gluing of glass with the STV® technology (page 29), which makes the window statics better and the thermal insulation coefficient lower. Moreover, the window elements are lighter, which makes it easier to close and open the windows.



Warmth without compromise

Thanks to the excellent thermal insulation parameters of the entire window from $U_w=0,77 \text{ W/m}^2\text{K}$, windows in the Gealan S 9000 system can be used in energy-saving and passive constructions.



Windows ready for anything

The use of Gealan ACRYLCOLOR® (page 28) will make your windows not only take on new colours, but also will be scratch-resistant and will keep their shape and colour for many years. A full range of veneers is available for this system.



More light

Gealan S 9000 windows in the LUMAXX® version (page 25) will provide more light to your rooms thanks to the ultra-low profiles of 103 mm.

Fixed



Fixed with sash



Tilting



Side hung



Tilt and turn



Available colours
GEALAN ACRYLCOLOR®
(page 28)



B

Class

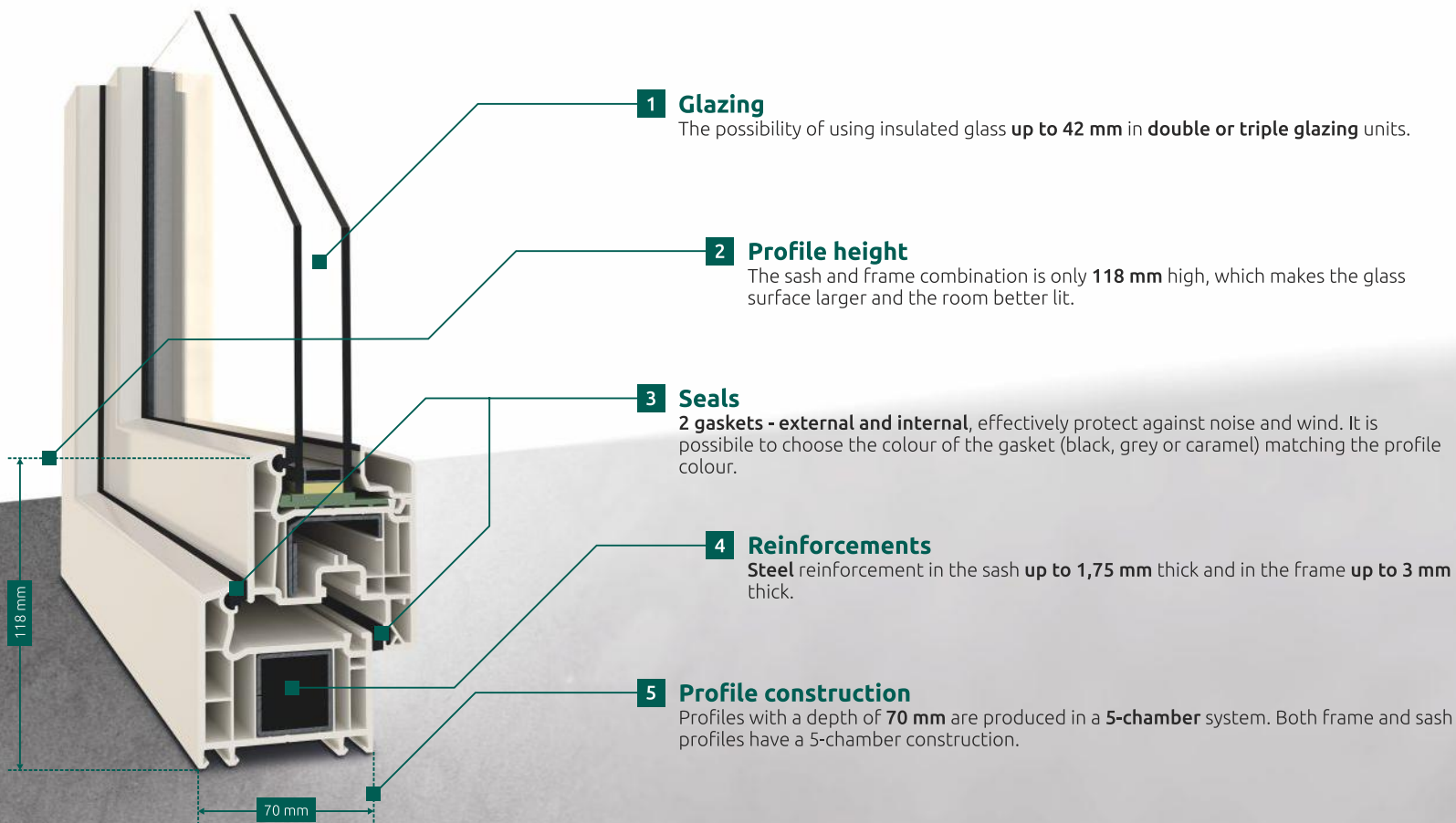

1 Glazing

The possibility of using insulated glass **up to 42 mm** in **double or triple glazing** units.

2 Profile height

The sash and frame combination is only **118 mm** high, which makes the glass surface larger and the room better lit.

3 Seals

2 gaskets - external and internal, effectively protect against noise and wind. It is possible to choose the colour of the gasket (black, grey or caramel) matching the profile colour.

4 Reinforcements

Steel reinforcement in the sash **up to 1,75 mm** thick and in the frame **up to 3 mm** thick.

5 Profile construction

Profiles with a depth of **70 mm** are produced in a **5-chamber** system. Both frame and sash profiles have a 5-chamber construction.

118 mm

70 mm

When you are looking for outward opening windows.

VEKA PERFECTLINE

We use the **VEKA Perfectline** system in the offer of the Szach-Mat Window Factory for the production of side-hung windows.



The highest A class

Perfectline profiles have outer walls with a thickness of over 2,8 mm, which places them in the highest A class according to the classification specified in the PN-EN 12608: 2004 standard. This guarantees the excellent static and insulating properties of the profiles.



Additional benefits

The glazing unit installed in the profiles at a depth of 21 mm makes Perfectline windows less susceptible to dew. They are also more difficult to force.



Pretty in everything nice

Perfectline has a wide range of colours and finishes. Black, gray or caramel gaskets, matched to the finish of the profiles, make the windows a perfect match for any facade.



Design with a classic look

The simple, classic look of the profiles makes the VEKA Perfectline windows a perfect complement to any facade. For lovers of tradition, it is possible to use muntins: internal, external, glued or dividing the window structure.



Safe angle

The windows can be equipped with various types of anti-burglary fittings, and with a 13 mm axis of the rebate and steel reinforcement, the profiles are perfect for securing your home against removal of the sash, breaking the window or burglary.

Fixed



Fixed with sash



Tilting



Side hung



Tilt and turn



Side hung outside



A

Class





FEEL WHAT
PRESTIGE
IS

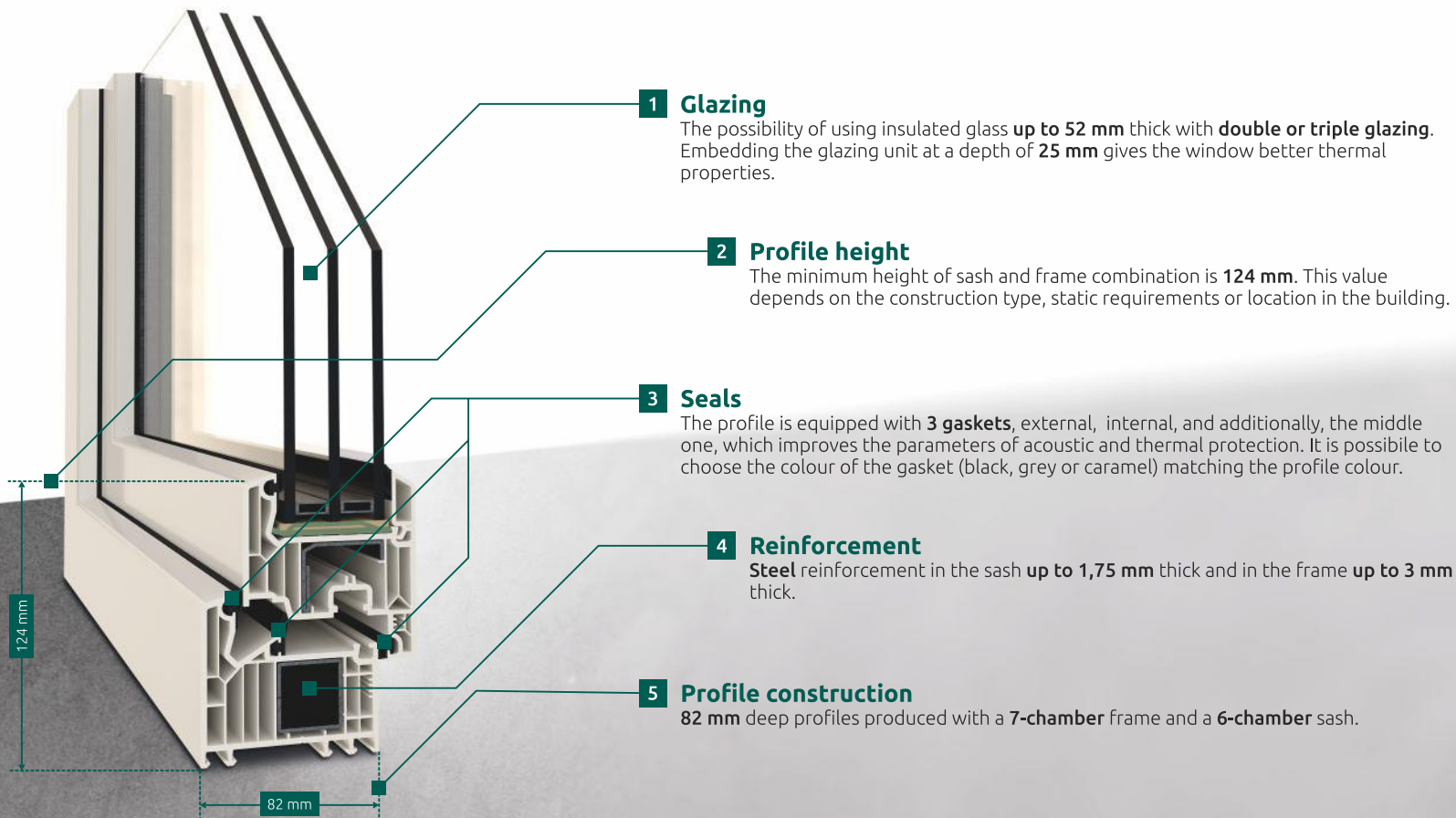

1 Glazing

The possibility of using insulated glass **up to 52 mm** thick with **double or triple glazing**. Embedding the glazing unit at a depth of **25 mm** gives the window better thermal properties.

2 Profile height

The minimum height of sash and frame combination is **124 mm**. This value depends on the construction type, static requirements or location in the building.

3 Seals

The profile is equipped with **3 gaskets**, external, internal, and additionally, the middle one, which improves the parameters of acoustic and thermal protection. It is possible to choose the colour of the gasket (black, grey or caramel) matching the profile colour.

4 Reinforcement

Steel reinforcement in the sash **up to 1,75 mm** thick and in the frame **up to 3 mm** thick.

5 Profile construction

82 mm deep profiles produced with a **7-chamber** frame and a **6-chamber** sash.

When you are looking for a "mercedes" among PVC windows.

VEKA SOFTLINE 82 MD

VEKA Softline 82 MD windows are a modern solution characterized by the highest energy efficiency. They are designed for passive buildings and dedicated to all those who value insulation parameters and a classic look.



The highest A class

The Softline 82 MD profiles have outer walls with a thickness of over 2,8 mm, which places them in the highest A class according to the classification specified in the PN-EN 12608: 2004 standard. This guarantees the excellent static and insulating properties of the profiles.



Classic look, unique finishing options

VEKA Softline 82 MD are characterized by classic, universal design. The variety of available finishes will satisfy the needs of any project. A unique colour palette of VEKA Spectral (page 30) is available for the system. It is an ideal solution for demanding customers, offering ultra-matte, velvety and delicate to the touch profiles, and at the same time resistant to mechanical damage and weather conditions.



Energy efficiency at the highest level

VEKA Softline 82 MD windows are perfect for any project where the greatest attention is paid to minimizing heat loss. This solution is certified for use in energy-efficient and passive houses.



Windows on 4 sides of the world

VEKA Softline 82 MD is a complete system with a large number of additional solutions, allowing each building to be comprehensively equipped with functional joinery of high aesthetic value.



Your Home is your castle

The windows can be equipped with various types of anti-burglary fittings. The 13 mm axis of the rebate and the steel reinforcements prevent sash removal, breaking the window and burglary.

Fixed



Fixed with sash



Tilting



Side hung



Tilt and turn



Available colours
VEKA SPECTRAL
(page 30)



A

Class



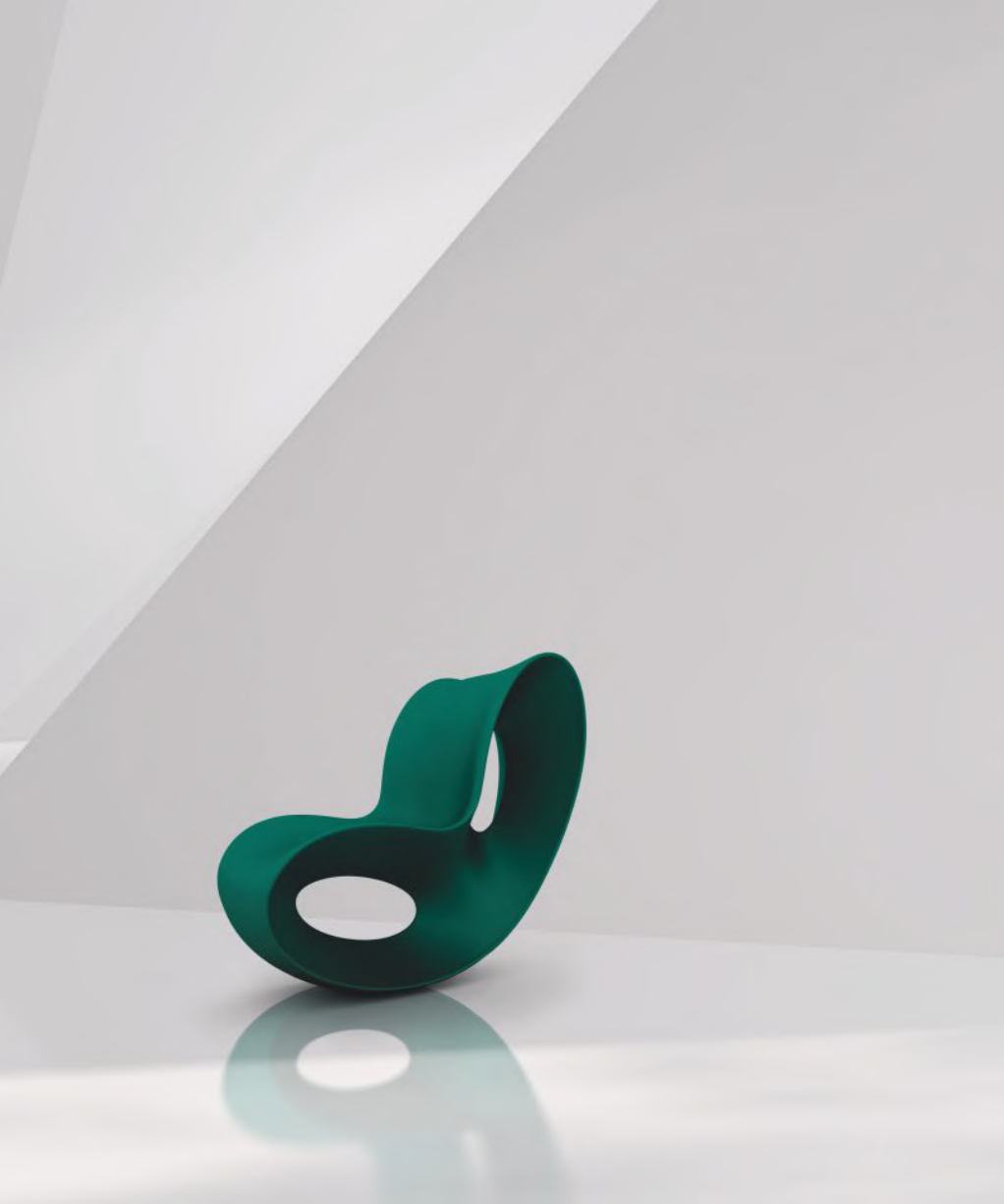

OPEN UP TO
DESIGN

VEKA DANLINE

Scandinavian solutions

Danline is a recommended choice for customers who appreciate traditional and proven Scandinavian solutions, previously available only for wooden windows. You receive a functional product at an affordable price, which is easy to clean and maintain.

✓ Outward opening windows

Danline windows open outwards, and among the available functions there are: top-swing, top-hung, side-swing and side-hung as well as opening with traditional hooks instead of a handle.

✓ Dedicated solutions

The Danline series has a dedicated handle in a special shape and a safe opening limiter that allows you to stop the sash in the selected position.



side-hung



top-hung



top-swing



side-swing

- 1 When using a 3-pane glazing unit, it is possible to achieve an insulation coefficient U_w of 0,89 W/m²K.
- 2 Profile width of 116 mm.
- 3 6 chambers in the frame and 5 chambers in the sash.
- 4 2 gaskets: external and internal.



ALU-CLAD VEKA SOFTLINE 82 MD

Perfect combination of PVC and ALU

ALU-CLAD VEKA Softline 82 MD combines the advantages of PVC windows with the aesthetics of aluminum windows. It is an excellent alternative to wooden windows with an aluminum cover.

✓ 4in1 package

Economics, ease of maintenance, durability and modern appearance are the features that make alu-clad PVC windows an excellent choice for even the most demanding customers.

✓ Endless possibilities

A wide range of colours from the RAL and NCS palettes makes it possible to adapt the windows to any facade style.

✓ Less expense

PVC windows in combination with aluminum are an advantageous alternative to much more expensive alu-clad wooden windows.

✓ Perfect parameters

Increased resistance and durability to weather conditions of PVC windows with an aluminum cover goes hand in hand with excellent thermal insulation parameters. These windows are perfect for energy-effective and passive buildings.



Available colours
VEKA SPECTRAL
(page 30)

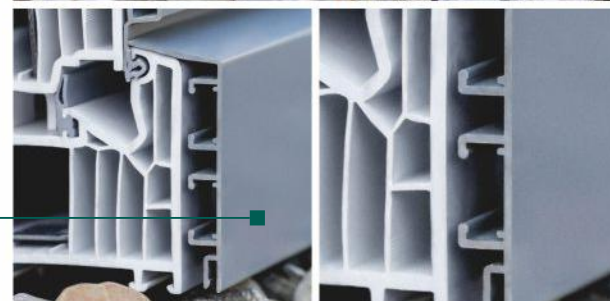

ALU-CLAD

GEALAN KUBUS®

Less means more

Gealan KUBUS® is a new look at window joinery, which perfectly fits the idea of transparent architecture. Large glazing enables effective lighting of the rooms and creates wide possibilities in interior design. From the inside, the profiles form a single, flush surface, and the clear contours of the rebate emphasize a coherent, modern look from the outside.

100 mm is a convincing argument

Both the combination of the frame with the sash and the fold with the movable mullion have the same width, equal to **100 mm**.

✓ Easy care

The smooth contours of the frame and the complete absence of frame gaskets allow for convenient maintenance. The perfectly designed step in the frame creates a warm middle seal.

✓ Windows without frames

The optimal shape gives architects a unique opportunity to design glazing without a visible frame.

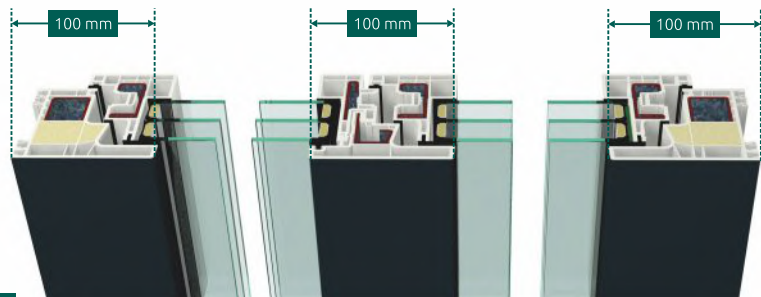

Available colours
GEALAN ACRYLCOLOR®
(page 28)



GEALAN LUMAXX®

Less framework, more light

Gealan LUMAXX® is an interesting combination of a traditional frame with a lowered sash, which in ready windows allows you to increase the glass area by up to **25%** compared to standard solutions.

Noticeably narrower window frames

The low frame-sash combination is **103 mm** high, and the post-sash connection is only **106 mm** wide.

✓ Optimal geometry

All the geometries of the profiles have been optimized, which allowed to reduce their height to a minimum, taking care to maintain the proportion between the thermal insulation properties and the window statics.

✓ No compromise

Except for narrowing the profiles, no other compromises were made when designing this system. The steel reinforcement used in it allows us to construct large windows up to 2,5m high.

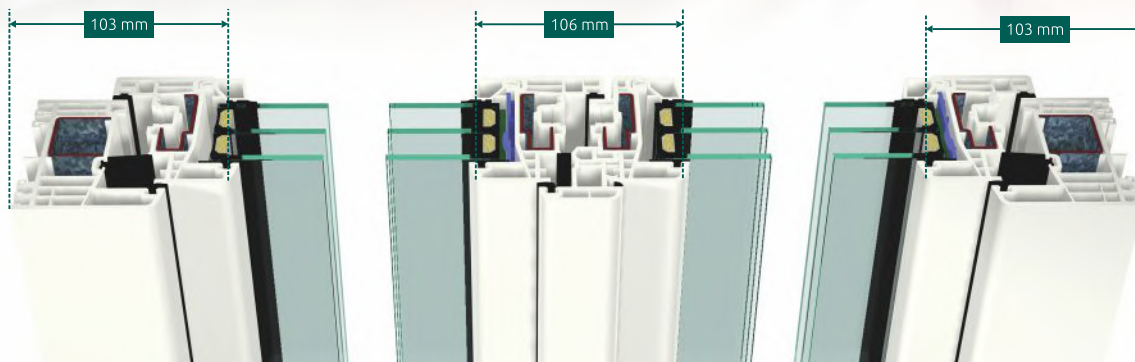

Available colours
GEALAN ACRYLCOLOR®
(page 28)

GEALAN LINEAR®

Minimalism and visual perfection

The innovative Gealan LINEAR® system is characterized by minimalism and visual perfection. The system is based on simple contours, which are the leading trend in contemporary architecture. The expressive shapes of the sashes with a 4° rebate inclination and glazing beads in a 90° optic create a unique, modern design. The complementation of the system advantages is its low folding height - 110 mm, which allows the construction of impressive, large windows.



Potential

The innovative structure of the system has been focused on meeting the current and future market expectations.



Versatility of applications

A complete system designed for the construction of windows, balcony doors and entrance doors.



Sashes with a rebate inclination of 4° and 90° glazing beads.

Combination of frame and sash height of only 110 mm.



KLIKK

Click and done

KLIKK is an ideal solution for quick installation of windows in halls made of sandwich panels and window replacement without the need to disassemble the old frame. A special PVC or aluminum window frame with an integrated masking profile on the inside and a special angle on the outside makes the installation of windows really easy.

- ✓ **Great look**
Aesthetic finish between the wall/panel and the window frame from the outside and the inside.
- ✓ **Perfect parameters**
KLIKK is a PVC or ALU window joinery with excellent technical parameters.
- ✓ **Economy**
Save time and money thanks to the comprehensive installation of windows without the need to use additional materials and workload.



Available colours
GEALAN ACRYLCOLOR®
(page 28)

KLIKK
fastening
system

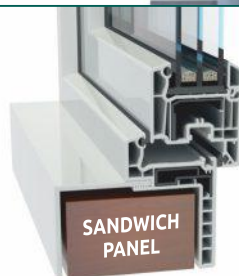

GEALAN ACRYLCOLOR®

What is Gealan ACRYLCOLOR®?

During co-extrusion, the white PVC profile base and the coloured acrylic glass (PMMA) melt together. The result is a high-quality surface of Gealan ACRYLCOLOR® profiles, which is characterized by unprecedented properties, and which refines and protects plastic windows for a long time.

See all the colours

The colour palette is constantly adapted, optimized and expanded in line with current market trends. Standard colours include nine colour shades, and special colours more than 50 shades.



Check out all GEALAN ACRYLCOLOR® shades

- ✓ **No chipping**
The durable combination of the ACRYLCOLOR coating with hard PVC profile prevents the paint from chipping and peeling.
- ✓ **Persistent colours**
Acrylic glass is colour-fast and fade-resistant.
- ✓ **Easy care**
The homogeneous surface makes the windows easy to keep clean.
- ✓ **Scratch removal**
Any scratches on the Gealan ACRYLCOLOR® surface can be easily removed with a Mirlon cleaning cloth.
- ✓ **Aging resistance**
The high-class surface of the profiles is extremely durable and resistant to the passage of time.
- ✓ **Protection against damage**
Thanks to the use of acrylic glass, the profiles are resistant not only to various weather conditions, but also to mechanical damage.

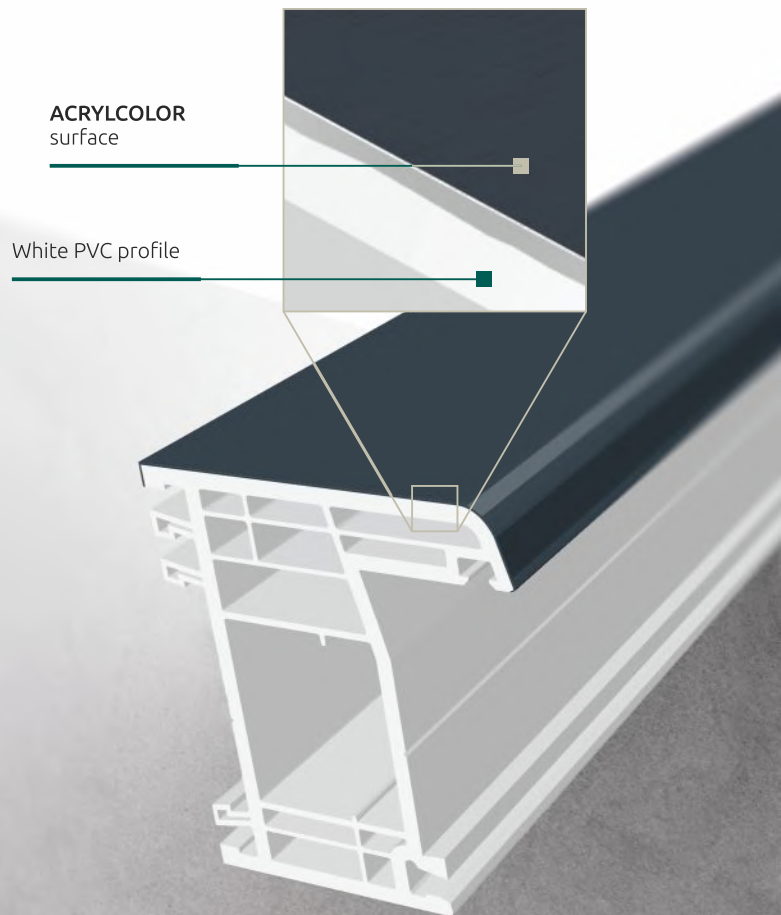

GEALAN STV®

Static dry glazing

The STV® technology consists in gluing the glass and the sash profile with a double-sided adhesive tape while maintaining traditional blocking. As a result of gluing the glass with the sash profile, the statics of the glass pane is transferred to the sash, thus the entire system becomes more stable. What is more, thanks to this solution even larger window constructions are possible and windows of standard sizes can be produced without steel in the sash.

✓ Better statics

The use of STV® and steel reinforcement in the sash allows the production of really big windows.

✓ Lighter wings

The lack of steel reinforcements minimizes the work related to the adjustment of windows, which results in a lower weight of the sashes, thus the closing and opening of the windows becomes lighter.

✓ Additional protection against burglary

Thanks to its properties, the STV® tape additionally protects the windows and reduces the risk of burglary to a minimum.

✓ Reliability

Windows manufactured with the STV® Technology do not require adjustments so many times, ensuring reliability for many years and limiting the service visits to minimum.

Large window constructions thanks to
the use of steel reinforcement and STV®



VEKA SPECTRAL

Extremely elegant appearance

VEKA SPECTRAL ultra-matt surface finish surprises with its unique appearance. There has never been such a perfectly matte plastic window surface before! They are velvety and delicate to the touch, and at the same time they are resistant to mechanical damage and the effects of unfavorable weather conditions.

- ✓ **Weatherproof**
Profiles with the SPECTRAL finish achieved excellent results in tests carried out in extreme laboratory conditions as well as in extreme weather conditions.
- ✓ **Resistant to aging**
Environmental simulations (UV radiation, irrigation, temperature and humidity) confirmed top-class reliability.
- ✓ **Resistant to damage**
High resistance to abrasion and mechanical damage has been confirmed by laboratory tests.
- ✓ **Chemical resistant**
Profiles have high chemical resistance.
- ✓ **Dirt-resistant**
Anti-graffiti effect making the window coating easily washable.

VEKA SPECTRAL is among others...

Elegant high-quality surface

Noble matte finish

Surprising delicacy to the touch

Exclusive nature

Beautiful shades of fashionable
colours

High resistance to external factors

High resistance to mechanical
damage

Surface finish resistant to stains,
fingerprints and other
contaminants

Ease of cleaning and care

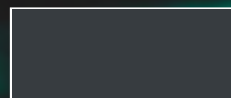

Anthracite
ultra-matt



Navy blue
ultra-matt

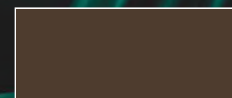

Sepia brown
ultra-matt

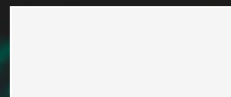

White
ultra-matt



Wine red
ultra-matt



Dark green
ultra-matt

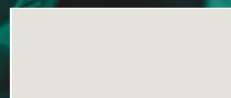

Milky white
ultra-matt

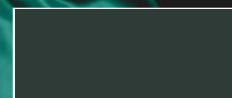

Monumental green
ultra-matt

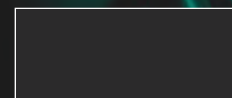

Graphite black
ultra-matt



Platinum gray
ultra-matt



Umbra
ultra-matt



White tender oak
ultra-matt



Gray tender oak
ultra-matt

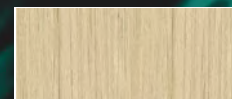

Antique tender oak
ultra-matt

*the colours are illustrative only and may differ from the real ones

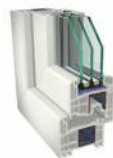

Name of the profile	GEALAN S 8000	GEALAN S 9000	VEKA PERFECTLINE	VEKA SOFTLINE 82 MD
Number of chambers in the frame / sash	6 / 6	6 / 6	5 / 5	7 / 6
Profile height	116 mm	118 mm	118 mm	124 mm
Profile depth	74 mm	82,5 mm	70 mm	82 mm
Profile class	B class	B class	A class	A class
Number of seals	2	3	2	3
Thickness of the glazing unit	up to 48 mm	up to 54 mm	up to 42 mm	up to 52 mm
Acoustic protection*	34 - 47 dB	34 - 48 dB	34 - 42 dB	34 - 47 dB
Energy efficiency*	from 0,86 W/m ² K	from 0,77 W/m ² K	from 0,89 W/m ² K	from 0,77 W/m ² K



VEKA DANLINE	VEKA SOFTLINE 82 MD with ALU-CLAD	GEALAN KUBUS®	GEALAN LUMAXX®	GEALAN LINEAR®
6/5	7/6	6/5	6/6	6/5
116 mm	124 mm	100 mm	103 mm	110 mm
70 mm	82 mm	82,5 mm	82,5 mm	74 mm
A class	A class	A class	A class	A class
2	3	3	3	3
up to 42 mm	up to 52 mm	up to 52 mm	up to 52 mm	up to 50 mm
34 - 42 dB	34 - 46 dB	34 - 45 dB	34 - 48 dB	34 - 47 dB
from 0,89 W/m ² K	from 0,77 W/m ² K	from 0,68 W/m ² K	from 0,77 W/m ² K	from 0,76 W/m ² K

*values for a reference window with dimensions of 1230x1480 mm



Winkhaus activPilot Concept

Standard fitting with
many extra options

Concept for tilt and turn windows combines functionality, safety and high comfort of use. The modern design makes this fitting also stand out in terms of aesthetics, giving the windows an innovative look. The locking system based on octagonal mushroom-shaped bolts enables easy change of the standard of anti-burglary protection of the window.

Max sash height in a rebate
2800 mm*

Max sash rebate width
1725 mm*

Max weight of sash
130 kg*

Large variety of individual solutions

Possible anti-burglary expansion
to **RC2** class

Possibilities of opening:
opening, tilting

*maximum dimensions and weight depend on the window construction and function

Winkhaus activPilot Select

Fittings with
concealed hinges

Select is a tilt and turn hardware with hinges that fit entirely in the space under the sash rebate. Thanks to this design of the hardware, the hinges are invisible when the window is closed. This is a very great aesthetic value, which allows you to freely choose colours and textures of windows and create interiors according to your preferences.

Max sash height in a rebate
2800 mm*

Max sash rebate width
1725 mm*

Max weight of sash
150 kg*

Leaf opening angle up to approx. **95°**

Adjustment without special tools

Hidden hinges in the sash

Better parameters of thermal insulation

Possibilities of opening:
opening, tilting

Winkhaus activPilot Tilt-first

Fitting with
reversed opening and tilting functions

Tilt-first allows you to change the order in which the window is opened, which is an important feature that protects against unwanted opening by children. This solution works well, among others, in kindergartens, schools, hotels as well as single or multi-family houses. To ensure additional security a special handle can be used, that opens the window only after turning the key.

Max sash height in a rebate
2200 mm*

Max sash rebate width
1600 mm*

Max weight of sash
130 kg*

It is possible to **change the order of opening functions of the window**

Additional security in the form of a **handle with a key**

Possibilities of opening:
opening, tilting

Winkhaus activPilot Comfort

Fitting with
ventilation all around the sash

Compared to traditional tilt and turn hardware systems, **Comfort** has, in addition to the tilt and tilt function, an additional function of setting the sash parallel to the frame. In this position, an approx. 6 mm gap forms between the sash and the frame, which enables natural ventilation with a securely locked window.

Max sash height in a rebate
2800 mm*

Max sash rebate width
1800 mm*

Max weight of sash
100 kg*

Compared to other fittings, it is possible to **ventilate the entire sash**

Burglary resistance up to **RC2** class

Possibilities of opening:
parallel holding, opening, tilting

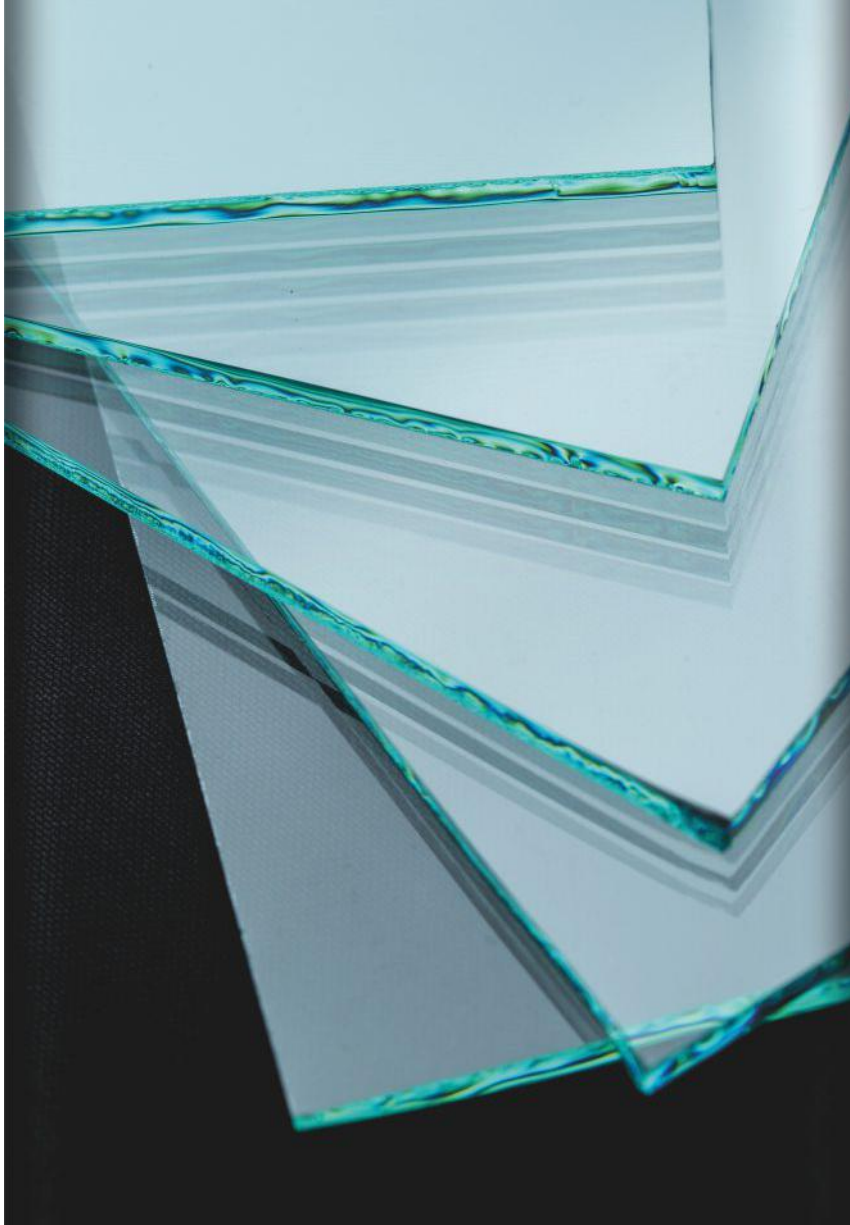

Thermally insulated glazing units

They consist of double or triple glass panes, with at least one of them covered with a special layer of a mixture of precious metals. The thin and invisible layer allows light and heat energy to pass through, while preventing heat from escaping from your home.



Soundproof glass

Silence is an important aspect of living a comfortable life. Soundproof glass can be used in all types of windows. Depending on the type of noise, we will match the appropriate glazing unit to the sound intensity in your environment.



Anti-burglary glass

They are recommended in all places where there is a risk of burglary. Such panes consist of several layers of a special anti-burglary film between thick glass panes. The effectiveness depends on the number of film layers.



Solar control glass

The main task of solar control glass is to protect rooms against overheating, ensuring greater comfort and reducing air-conditioning costs. In addition, modern solar control glass is characterized by high thermal insulation properties, limiting heat loss in the winter.

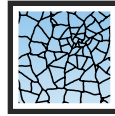

Safety glass

They are indispensable in all places where user's safety is a priority. Our offer includes 2 types of safety glass: first, hardened ESG glass, which is characterized by greater resistance to the mechanical damage when compared to the ordinary glass, and second type, laminated VSG glass, with a special protective film between the glass panes.

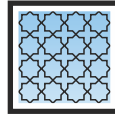

Ornamental glass

Thanks to their decorative qualities, they give the building a unique look. Ornamental glass is often used in bathrooms to ensure privacy.



Glass with warm spacer bars

Glass and metal are good energy conductors, therefore a lot of heat is lost in the distance areas between the two glass panes in the glazing unit. A warm spacer bar, unlike traditional aluminum, not only effectively eliminates the cold bridge, but also reduces the condensation of water vapor on the glass surface and improves the aesthetics of the window.

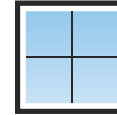

Glass with muntin bars

Window muntins are a stylish window decoration used not only in traditional architecture. Thanks to the variety of shapes, colours and types, they can also give a unique look to modern buildings.

ACCESSORIES



STANDARD handles



FKS 1005



FKS 1005A
with a key

PREMIUM handles



HP 099Z



HP 099K
with a key

handles FOR WINDOWS OPENING OUTWARDS



FKS 1005V



FKS 1012AV
with a key

Available colours

RAL 9016	white
F1	silver
F2	champagne gold
F3	gold
F4	old gold
F9	steel

*the colours are illustrative only and may differ from the real ones
*colours available for each model

WINDOW accessories



oval covered
Rosette



KISI



Roller shutters

An external roller shutter will provide additional protection for your home against burglary. Our offer includes both surface-mounted roller blinds as well as concealed roller blinds hidden in the facade.

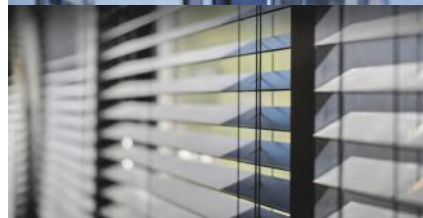

Facade blinds

It is a modern solution used to control the flow of light and temperature to the building. Horizontal slats made of aluminum come in various shapes and widths.

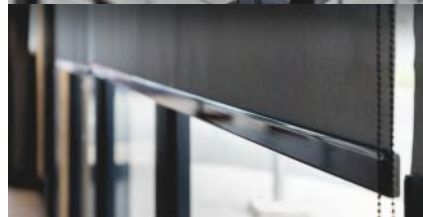

Blinds and shutters

Fabric roller blinds are one of the forms of covering windows against sunlight. Moreover, roller blinds provide additional protection against overheating the room.



Window sills

The finishing of the rooms cannot be done without a window sill, which perfectly complements the window arrangement. Our offer includes external and internal window sills.



Mosquito nets

Problems with insects are very common. Mosquito nets will be useful to protect your house. We offer rolled, framed, pleated and door versions.

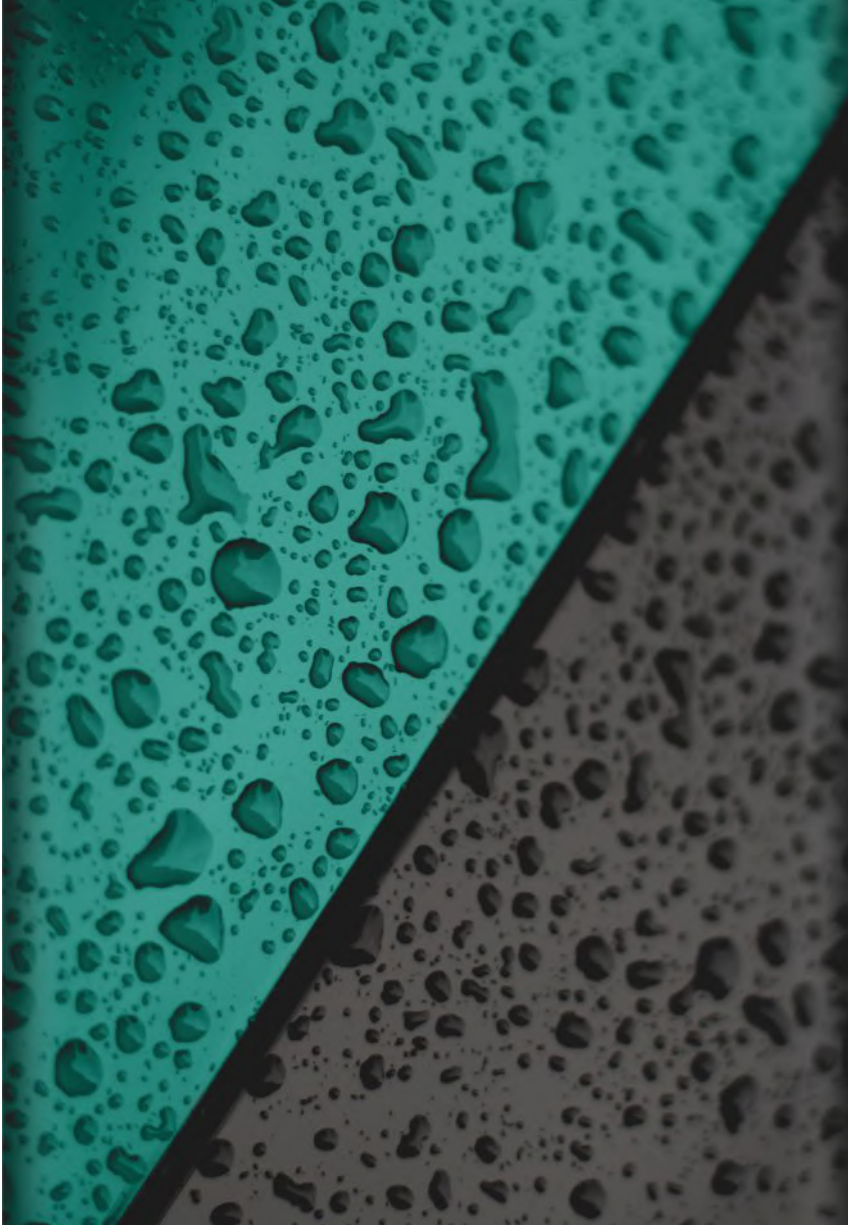

VEKA SPECTRAL

The VEKA SPECTRAL ultra-matt surface finish surprises with its unique appearance. There has never been such a perfectly matte plastic window surface! They are velvety and delicate to the touch, and at the same time they are resistant to mechanical damage and the effects of unfavorable weather conditions.

More about VEKA SPECTRAL can be found on page 30.

GEALAN Acrylcolor®

The advantages of plastic windows made in Gealan ACRYLCOLOR® technology have been obvious for over 40 years. The acrylic glass coating ensures extraordinary durability, thanks to which the window surface is extremely resistant to weather conditions and durable like no other. Gealan ACRYLCOLOR® guarantees colour consistency in an impressively rich palette of shades, including metallic shades.

More about Gealan ACRYLCOLOR® on page 28.



White
structural

RAL 9010

White creamy
structural

RAL 9001

Papyrus white
structural

RAL 9018

Light gray
structural

RAL 7035

Gray silky
structural

RAL 7044

Gray agate
structural

RAL 7038

Gray silver
structural

RAL 7001

Gray concrete
structural

RAL 7023

Quartzite gray
structural

RAL 7039

Basalt gray
structural

RAL 7012

Slate gray
structural

RAL 7015

Anthracite gray
structural

RAL 7016

Signal gray
smooth

RAL 7004

Quartzite gray
smooth

RAL 7039

Basalt gray
smooth

RAL 7012

Slate gray
smooth

RAL 7015

Anthracite gray
smooth

RAL 7016

Ginger oak
wood-like

Realwood

Honey oak
wood-like

Realwood

Bleached oak
wood-like

Realwood

Light oak
wood-like

Realwood

Golden oak
wood-like

Realwood

Winchester XA
wood-like

Realwood

Walnut
wood-like

Realwood

Black and brown
matte

Black

Black
matte

*the colors are illustrative only and may differ from the real ones

None of the colours suits you?

NO PROBLEM

We paint windows in each of the colours of the **RAL** and **NCS** palette.

INSPIRATIONS





INSPIRATIONS





INSPIRATIONS





INSPIRATIONS





INSPIRATIONS





Szach-Mat Window Factory

Office and headquarters

ul. Kartuska 354AA
80-125 Gdańsk, Poland

Factory

ul. Rzemieślnicza 56
83-304 Załęże, Przdkowo, Poland

M +48 500 100 843

M +48 500 100 883

M +47 463 54 379

E windows@szach-mat.eu

www.szach-mat.eu

VAT no PL5971400696

